

TAGS

SHIPPING TAGS

10 pt. Manila



Acorn Paper Products has an assortment of tagging systems and merchandising tags to meet your needs. From shipping tags to merchandise tags, we carry the most popular tags along with hard to find specialty tags. If you do not see what you need listed here, please contact your Acorn Paper Products representative for assistance.

ITEM (PLAIN)	ITEM (W/STRING)	ITEM (W/WIRE)	TAG NO.	SIZE	PER CASE
230114911	23011591	23011691	1	2-3/4" X 1-3/8"	1000
230114921	23011592	23011692	2	3-1/4" X 1-5/8"	1000
230114931	23011593	23011693	3	3-3/4" X 1-7/8"	1000
23011494	230041	23011694	4	4-1/4" X 2-1/8"	1000
70211495	23011595	23011695	5	4-3/4" X 2-3/8"	1000
23011496	23011596	23011696	6	5-1/4" X 2-5/8"	1000
23011497	23011597	230697	7	5-3/4" X 2-7/8"	500
230114981	23011598	230116981	8	6-1/4" X 3-1/8"	500

13 PT AND COLORS ARE AVAILABLE



INVENTORY TAGS

3-1/8" x 6-1/4"

Our line of inventory specific tags will make counting, classifying and tagging your inventory easier and more economical. Tags are available in several styles including tear off stub, two part and NCR. They are also available pre-numbered for your convenience. Please contact your Acorn Paper Company Sales representative for more information.



MANILA 1 PART W/STUB	CARBON 2 PART	NCR 2 PART	NUMBERED
----------------------	---------------	------------	----------

230150600	22715100	23015300	000 - 499
230150601	22715101	23015301	500 - 999
230150602	22715102	23015302	1000 - 1499
230150603	22715103	23015303	1500 - 1999
230150604	22715104	23015304	2000 - 2499
230150605	22715105	23015305	2500 - 2999
230150606	22715106	23015306	3000 - 3499
230150607	22715107	23015307	3500 - 3999
230150608	22715108	23015308	4000 - 4499
230150609	22715109	23015309	4500 - 4999
230150610	22715110	230153010	5000 - 5499
230150611	22715111	230153011	5500 - 5999
230150612	22715112	230153012	6000 - 6499
230150613	22715113	230153013	6500 - 6999
230150614	22715114	230153014	7000 - 7499
230150615	22715115	230153015	7500 - 7999
230150616	22715116	230153016	8000 - 8499
230150617	22715117	230153017	8500 - 8999
230150618	22715118	230153018	9000 - 9499
230150619	22715119	230153019	9500 - 9999





TAGS

MERCHANDISE TAGS

1000 per Box, No String

Use these tags for marking and labeling merchandise or other items. Various colors are available to make identification and classification simple. They are available in a variety of assorted sizes for a broad range of uses.



White

ITEM	SIZE	SIZE NUMBER
230121111	15/16" X 9/16"	1S
230121071	1-1/16" X 3/4"	2S
230121061	1-1/4" X 13/16"	3S
230121051	1-1/2" X 1"	4S
230121041	1-3/4" X 1-1/8"	5S
230121031	1-15/16" X 1-1/4"	6S
22712102	2-1/4" 1-7/16"	7S
70212101	2-3/4" 1-3/4"	8S
23012100	3-3/16" X 1-15/16"	9S

ALSO AVAILABLE WITH COTTON OR RAYON STRING

Red

ITEM	SIZE	SIZE NUMBER
230121062	1-1/4" X 13/16"	3S
230121052	1-1/2" X 1"	4S
230121042	1-3/4" X 1-1/8"	5S
230121032	1-15/16" X 1-1/4"	6S
230121022	2-1/4" 1-7/16"	7S
230121012	2-3/4" 1-3/4"	8S
230121002	3-3/16" X 1-15/16"	9S

Green

ITEM	SIZE	SIZE NUMBER
230121063	1-1/4" X 13/16"	3S
230121053	1-1/2" X 1"	4S
230121043	1-3/4" X 1-1/8"	5S
230121033	1-15/16" X 1-1/4"	6S
230121023	2-1/4" 1-7/16"	7S
230121013	2-3/4" 1-3/4"	8S
230121003	3-3/16" X 1-15/16"	9S

Yellow

ITEM	SIZE	SIZE NUMBER
230121064	1-1/4" X 13/16"	3S
230121054	1-1/2" X 1"	4S
230121044	1-3/4" X 1-1/8"	5S
230121034	1-15/16" X 1-1/4"	6S
230121024	2-1/4" 1-7/16"	7S
230121014	2-3/4" 1-3/4"	8S
230121004	3-3/16" X 1-15/16"	9S

INSPECTION TAGS

1000 per Box, Black Print

Preprinted tags make inspecting merchandise or inventory simple. Preprinted with "Rejected" "Repairable or Rework" and "Accepted" headings.



ITEM	TEXT	TAG COLOR
23015156	REPAIRABLE OR REWORK	GREEN
22715155	ACCEPTED	BLUE
23015154	REJECTED	RED

SHIPPING SUPPLIES

TAGS

METAL RIM TAGS

500 per box

These are manufactured using fine heavy stock with a nickel plated zinc rim. Various colors are available to make identification and classification simple. A heavy cord matches the tag color.



White

ITEM	SIZE (DIAMETER)
230143121	1-5/16"
230143131	1-1/4"
230143141	1-9/16
230143151	1-7/8
230143161	2 1/4"

Yellow

ITEM	SIZE (DIAMETER)
230143124	1-5/16"
230143134	1-1/4"
230143144	1-9/16
230143154	1-7/8
230143164	2 1/4"

Red

ITEM	SIZE (DIAMETER)
230143122	1-5/16"
230143132	1-1/4"
230143142	1-9/16
230143152	1-7/8
230143162	2 1/4"

Green

ITEM	SIZE (DIAMETER)
230143123	1-5/16"
230143133	1-1/4"
230143143	1-9/16
230143153	1-7/8
230143163	2 1/4"

TAG FASTENERS

Acorn Paper Product carries a selection of tag fasteners to fit each fastening application. If you do not see what you need listed here, please contact your Acorn Paper Products representative for assistance.



Tag Wires

ITEM	DESCRIPTION
23018467	7-1/2", 26 GAUGE, 1000 PER BUNDLE
23012	12", 26 GAUGE, 1000 PER BUNDLE



Deadlock Tag Fasteners

ITEM	DESCRIPTION
23018546	SEMI-BLUNT POINT "O" STYLE
23018541	SHARP POINT "D" DIAMOND STYLE



Security Ties

ITEM	SIZE	CASE
70318145	5" LONG	5000

WE CARRY SUPPLIES FOR MOST TAGGING SYSTEMS

TAGS

TAGGING SYSTEM

A wide selection of fastening and tagging systems is available from Acorn Paper Products. We also carry replacement parts, barbs and needles for most popular systems.

If you do not see what you need listed here, please contact your Acorn Paper Products representative for assistance.

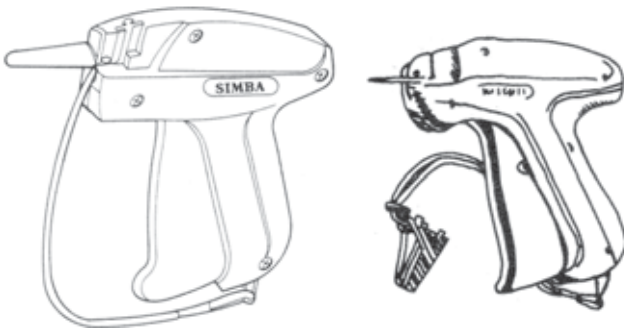

Grip Tools

ITEM	DESCRIPTION
70218023	SIMBA™ ECONOMY SYSTEM
70218010	MINI TACH-IT® GUN
70218111	STANDARD NEEDLES

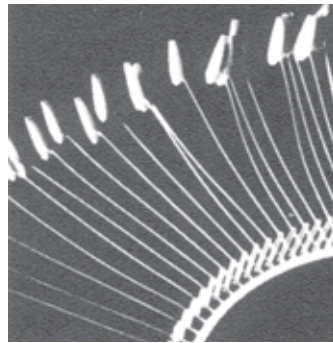
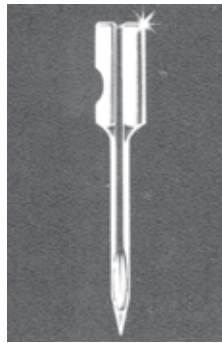

Replacement Needles and Barbs

ITEM	DESCRIPTION	SIZE
70218001	TACH-IT BARBS	1"
70218002	TACH-IT BARBS	2"
7026041	TACH-IT BARBS	3"
70218022	TACH-IT FINE BARBS	1"
70218035	TACH-IT FINE BARBS	2"

Plastic Fasteners

ITEM	SIZE	TYPE
7022012	1/2"	GENERAL PUPOSE
702201	1"	GENERAL PUPOSE
702202	2"	GENERAL PUPOSE
702203	3"	GENERAL PUPOSE
70220121	1/2"	HEAVY DUTY
7022012	1"	HEAVY DUTY
7022022	2"	HEAVY DUTY
7022033	3"	HEAVY DUTY

STENCILS AND ROCKER PRINTERS

This blue stencil is heavy duty, long-lasting. It is available in a variety of sizes up to 4-1/2" x 8". The stencil tissue is attached to a heavy paper sheet that is perforated for easy removal after imaging is complete. Please contact your Acorn Paper Company Sales representative for more information.

FLAT AND ROCKER PRINTERS

Rocker Printers allow for quick and easy application of stencils onto packaging. A full line of stencils and inks are available. Please contact your Acorn Paper Company Sales representative for more information.

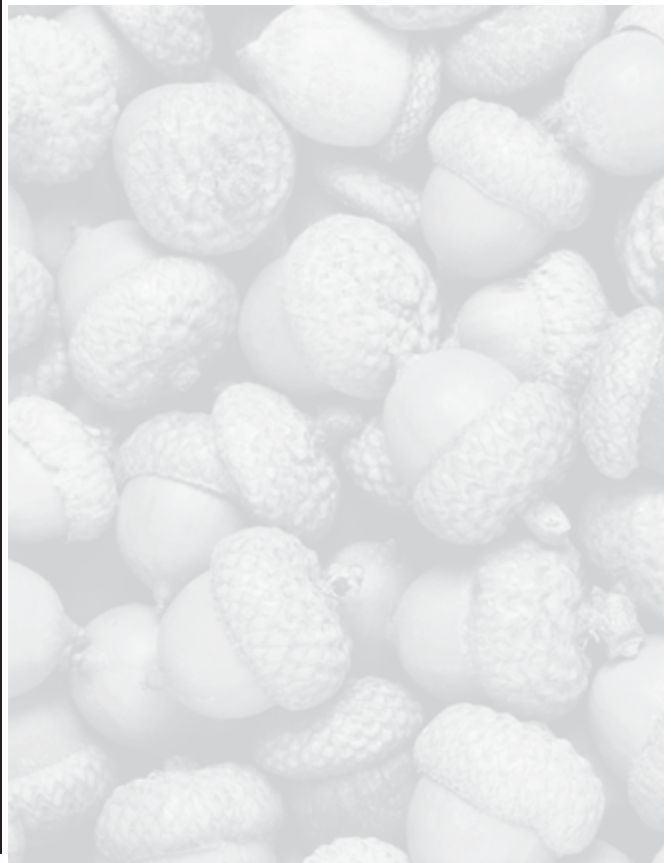

CUTTERS AND KNIVES

PAPER CUTTERS

These are the most versatile and dependable paper cutters available. Available in widths from 6" to 72".

STANDARD PACIFIC PAPER CUTTERS

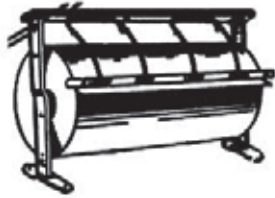

STANDING: FOR COUNTERS, PACKING ROOM TABLES, ETC.

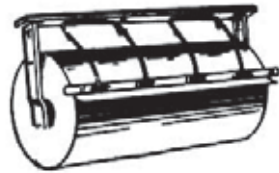

HANGING: FOR UNDER COUNTERS AND TABLES OR BETWEEN SHELVES.

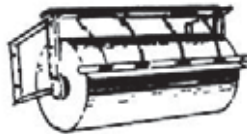

WALL BRACKET: FOR WALLS OR PARTITIONS AND UNDER SHELVING.

ITEM, STANDING	ITEM, HANGING	ITEM, WALL BRACKET	SIZE
1050611	1050612	1050613	6"
1050911	1050912	1050913	9"
105121	1051212	1051213	12"
1051511	105151	1051513	15"
105181	105182	1051821	18"
1052011	1052012	1052013	20"
105241	105024	105242	24"
1053012	105303	105302	30"
1053612	105364	105362	36"
1054011	1054012	1054013	40"
105481	1054812	10548	48"
1055411	1055412	1055413	54"
105605	1056012	1056013	60"
1057211	1057212	1057213	72"

CARTON SIZER

Carton sizers add a perforation type score to reduce carton depth. Cartons can be quickly altered for a variety of depths saving stock space and reducing shipping and packaging charges.

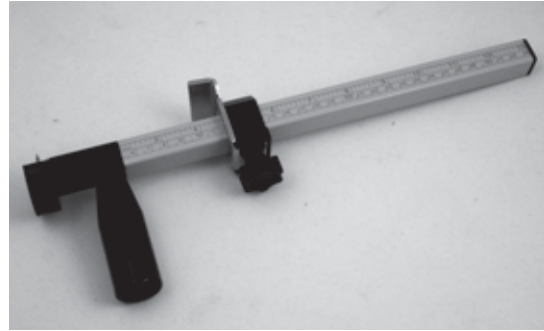

ITEM	DESCRIPTION
227100	ADJUSTABLE TOOL REDUCES BOX HEIGHT

KNIVES

Multi-purpose knife features a refillable blade. The blade is kept sharp by snapping off the end of the blade to reveal a new sharp edge. These replacement blades work with a variety of snap-off knives. Please contact your Acorn Paper Company Sales representative for more information.



LARGE SNAP BLADE KNIFE



LARGE REPLACEMENT SNAP BLADE



SMALL REPLACEMENT SNAP BLADE

Snap-off Cutters and Blades

ITEM	DESCRIPTION	PER PACK
22711470	LARGE SNAP BLADE KNIFE	100 PER CASE
22711461	LARGE REPLACEMENT SNAP BLADE	10 BLADES/TUBE
22711462	SMALL REPLACEMENT SNAP BLADE	10 BLADES/TUBE

SHIPPING SUPPLIES

CUTTERS AND KNIVES CONTINUED

Retractable knife features a refillable blade that retracts and locks for safety. These replacement blades work with a variety of retractable and fixed knives. Please contact your Acorn Paper Company Sales representative for more information.



HEAVY DUTY STANLEY RETRACTABLE UTILITY KNIFE

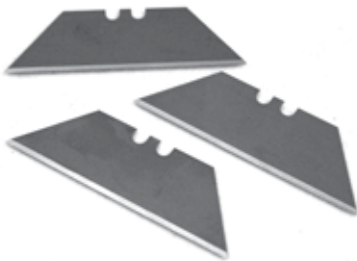

BLADES FOR RETRACTABLE UTILITY KNIFE

Retractable Utility Knives and Blades

ITEM	DESCRIPTION	PER PACK
22711749	HEAVY DUTY RETRACTABLE UTILITY KNIFE	1 / EA
2270101	HEAVY DUTY STANLEY RETRACTABLE UTILITY KNIFE	1 / EA
227112191	BLADES FOR RETRACTABLE UTILITY KNIFE	100/BOX
227119215	BLADES FOR STANLEY UTILITY KNIFE	5 PER PACK, 10 PACKS PER BOX

Basic utility and carton cutter known for reliability and economy. Reversible blade doubles blade life. Blade used is standard single edge blade.

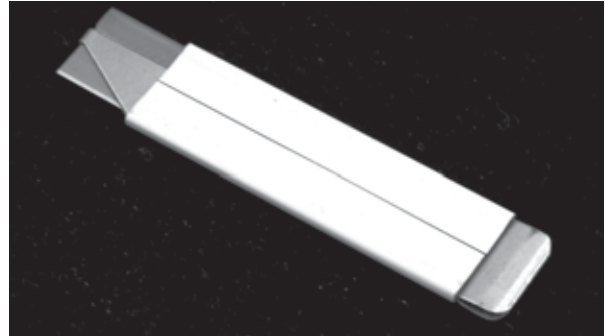

HANDI-CUTTER

Carton / Box Cutter

ITEM	DESCRIPTION	PER PACK
227114281	HANDI-CUTTER, SINGLE BLADE	12

This single edge blade is used to refill Acorn's carton and box cutter and many other knives, blade holders and scrapers. Please contact your Acorn Paper Company Sales representative for more information.



Single Edge Blades

ITEM	DESCRIPTION	PER PACK
227111019	SINGLE EDGE BLADES	100

SHIPPING SUPPLIES



TABLES AND SCALES

PACKING TABLE - BULMAN BRAND

This deluxe table features a multi-use design for packaging, shipping and sorting.

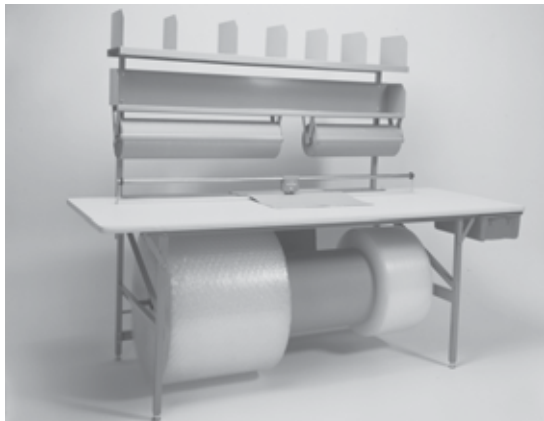

WRAP AND PACK TABLE

Simple design for packaging and shipping stations. A convenient bubble and foam roll dispensing rack is included. Please contact your Acorn Paper Company Sales representative for more information.

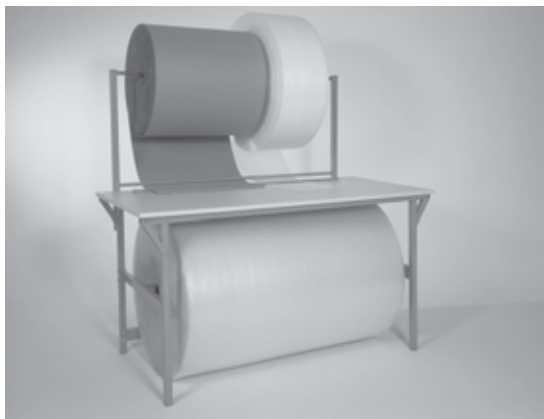

SCALES

Acorn paper carrier scales in a variety of configurations including table and floor models. Designs are available for shipping, production, part weighing and mail room use. Scales are available from letter to pallet size and more.



PACKING LIST ENVELOPES

1000 Per Case unless noted

Pressure sensitive backing attaches to almost anything – paper, wood, plastic, metal. Outside dimensions listed. For the inside dimensions, deduct 1/2".

PACKING LIST ENCLOSED



ITEM NO. 229529
4 1/2" X 5 1/2" ADM-52
BACKLOADING



ITEM NO. 229129
4 1/2" X 5 1/2" PQ12BL
BACKLOADING



ITEM NO. 229101
4 1/2" X 6" PQ1BL
BACKLOADING



ITEM NO. 2291022
7" X 5 1/2" PQ22BL
BACKLOADING



ITEM NO. 2291939
7 1/2" X 5 1/2" ADM-P19
TOPLOADING



ITEM NO. 229519
4 1/2" X 5 1/2" ADM-51
BACKLOADING



ITEM NO. 22929
4 1/2" X 6" ADM-F2
BACKLOADING



ITEM NO. 22900139
4 1/4" X 8" ADM C-13
BACKLOADING

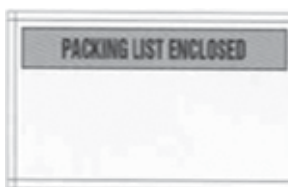

ITEM NO. 22924
5 1/2" X 10" PQ 24 BL
BACKLOADING



ITEM NO. 2291010
4 1/2" X 6"
(FLOURESCENT FACE)
PQ10BL
BACKLOADING

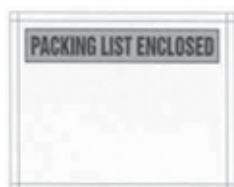

ITEM NO. 229199
7" X 5 1/2" PQ19BL
BACKLOADING

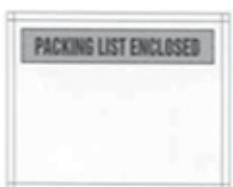

ITEM NO. 229259
6 1/2" X 5" PQ25BL
BACKLOADING

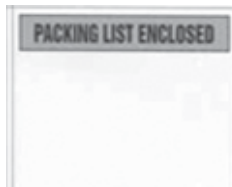

ITEM NO. 229321
7" X 6" PQ32BL
BACKLOADING



ITEM NO. 22959
6 3/4" X 5" (YELLOW BOX)
ADM-F5 TOPLOADING



ITEM NO. 229169
5 1/2" X 10"
ADM-C16
BACKLOADING

INVOICE ENCLOSED

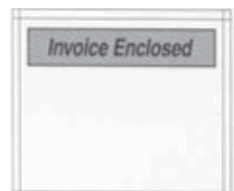

ITEM NO. 229103
4 1/2" X 6" PQ3BL
BACKLOADING

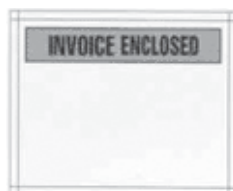

ITEM NO. 2291023
7" X 5 1/2" PQ23BL
BACKLOADING

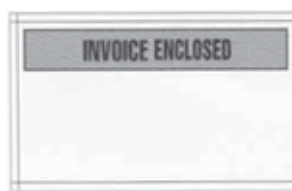

ITEM NO. 22927
5 1/2" X 10" PQ27BL
BACKLOADING

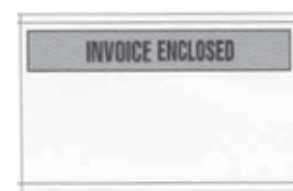

ITEM NO. 229162
5-1/2 X 10 ADM-C16IE
BACKLOADING

PACKING LIST ENVELOPES

INVOICE ENCLOSED CONTINUED

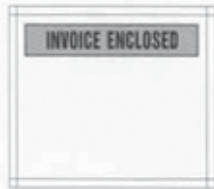

ITEM NO. 2295119
4 1/2" X 5 1/2"
ADM-51IE
BACKLOADING



ITEM NO. 229521
4 1/2" X 5 1/2"
ADM-52IE
BACKLOADING

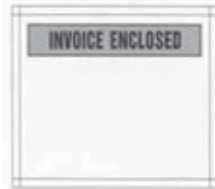

ITEM NO. 229139
4 1/2" X 5 1/2"
PQ13BL
BACKLOADING



ITEM NO. 229171
4 1/2" X 5 1/2"
PQ17BL
BACKLOADING

NO PRINTING



ITEM NO. 229119
4 1/2" X 5 1/2" PQ11BL
BACKLOADING



ITEM NO. 229105
4 1/2" X 6" PQ5BL
BACKLOADING



ITEM NO. 2291929
7" X 5 1/2" ADM-P19NP
TOPLOADING



ITEM NO. 229219
7" X 5 1/2" PQ21BL
BACKLOADING



ITEM NO. 229141 7" X 6"
(CLEAR FACE, ORANGE BACKING)
ADM C-14NP
TOPLOADING



ITEM NO. 2291619 5
1/2" X 10"
ADM-C16NP
BACKLOADING



ITEM NO. 2291014
4 1/2" X 9" PQ14EL



ITEM NO. 2291015
4 1/4" X 8" PQ15RF
RECESSED FACE



ITEM NO. 2291016
4 1/4" X 3" PQ16RF
RECESSED FACE



ITEM NO. 2291020
4 1/4" X 8" (RED BACKING)
PQ20RF RECESSED FACE



ITEM NO. 2291041
10" X 5 1/2" PQ41ST
SPECIAL TAPE



ITEM NO. 22970
10 3/4" X 6 3/4"
(PERORATED FACE)
PQ70BL
BACKLOADING



ITEM NO. 2297109
10" X 7" ADM-710NP
TOPLOADING



ITEM NO. 22910100
10" X 12" PQ100BL
BACKLOADING



ITEM NO. 2295129
4 1/2" X 5 1/2" ADM-51NP
BACKLOADING

PACKING LIST ENVELOPES

IMPORTANT INV/ PL ENCLOSED



ITEM NO. 229379
4 1/2" X 6" ADM-F37A
BACKLOADING



ITEM NO. 229104
4 1/2" X 6" PQ4BL
BACKLOADING

MATERIAL SAFETY DATA SHEET



ITEM NO. 2291099
6 1/2" X 5"
PQ99BL
BACKLOADING

AIRBILL ENCLOSED



ITEM NO. 2291060
6" X 10" PQ60BL
BACKLOADING

IBM STYLE



ITEM NO. 229229
4" X 8" IBM-2 OPEN END W/ LIP
ITEM NO. 229005
4" X 3" IBM-5
OPEN END SHORT FACE, RAZOR CUT

WITH AMERICAN FLAG



ITEM NO. 229121
4 1/2" X 5 1/2"
PQ-USA-12 PACKING LIST ENCL.
BACKLOADING

MISCELLANEOUS PACKING LIST ENVELOPES



ITEM NO. 22997
5 1/2" X 10" PQ-97
BACKLOADING



ITEM NO. 22998
6 1/2" X 5" PQ98-BL
BACKLOADING



ITEM NO. 2291020
5 1/4" X 8" GSA-20
MILITARY SPEC



ITEM NO. 229309
8-1/2" X 10-1/4"
GSA-30
MILITARY SPEC

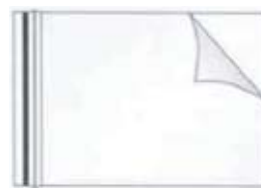

ITEM NO. 229046
4-1/2" X 7" ADM-R46
RECLOSABLE, NO PRINT
500/CSSPEC

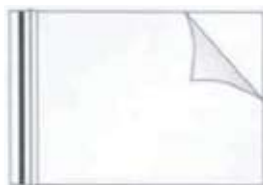

ITEM NO. 2298109
8-1/2" X 11" ADM-R-810
RECLOSABLE, NO PRINT
500/CS

Contact Acorn for others not shown

SHIPPING INDICATORS

DROP-N-TELL

This low cost device registers when a package receives an impact above a certain G force. It is not easily manipulated, thereby ensuring accurate readings. Sold by the each.



ITEM	"G" RATING RANGE
2300105	5
2300110	10
2301004	15
2300125	25
23050	50
23001100	100

TIP-N-TELL

This low cost device registers when a package has been tipped even slightly or completely knocked over. It is not easily manipulated, thereby ensuring accurate readings. Please contact your Acorn Paper Company Sales representative for more information.



ITEM	PER CASE
2301005	100

SHOCKWATCH

Shockwatch damage indicators react to outside force upon a package. It is available at various G ratings for use on a variety of item fragilities. Please contact your Acorn Paper Company Sales representative for more information.



Indicators

ITEM	"G" RATING RANGE	COLOR	PER CASE
2302100	100	GREEN	100
2300275	75	ORANGE	100
23045	50	RED	100
227651	25	YELLOW	100

HUMIDITY INDICATORS

The color of sensors on these cards changes when exposed to various levels of humidity. Pack cards near items that are sensitive to humidity to verify safe transit or storage. Meets many military and government specifications.

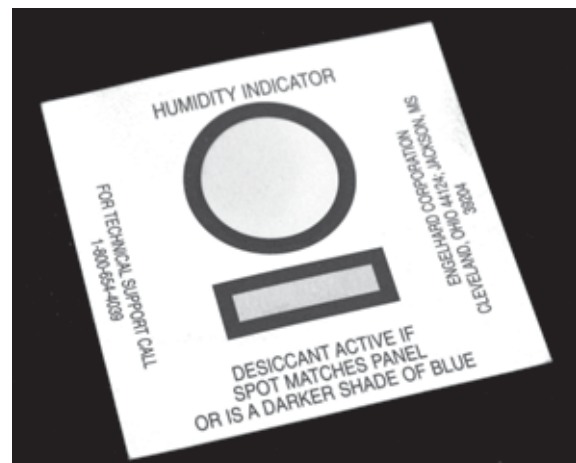

DESICCANT - GENERAL PUPOSE

Designed to control humidity, a desiccant bag is places inside the packed with sensitive items and reduces overall moisture. A variety of bag sizes is available.



ITEM	BAG SIZE	PER CONTAINER	LBS. PER CONTAINER
2271014	1/6	1200	24
2270333	1/3	700	25
2272005	1/2	550	27
2270001	1	300	29
2272002	2	150	29
2271004	4	500	156
22710081	8	300	188

ADHESIVE SPRAY

Acorn Paper Products carries a variety of the most used adhesive sprays for a variety of uses. Please contact your Acorn Paper Company Sales representative for specific usage information and recommendations.



ITEM	DESCRIPTION	SIZE	PER CASE
22677	3M SPRAY 77 ADHESIVE	16.5 OZ	12
226763	3M SPRAY 76 ADHESIVE	10 OZ.	12
22690	3M SPRAY 90 ADHESIVE	24 OZ	12
226947	SA-947 ADHESIVE SPRAY		12

GLUE STICKS

Acorn Paper Products carries a variety of glue guns, glues and accessories for manufacturing and sealing. A variety of glue types are available specific to your application. Hot melt systems are also available for heavy production. If you do not see what you need listed here or desire more information, please contact your Acorn Paper Products representative for assistance.

Glue Guns

ITEM	DESCRIPTION	WATTS
226700	INDUSTRIAL GLUE GUN	250
226750	HIGH VOLUME GLUE GUN	80

Sticks

ITEM	DESCRIPTION	QUANTITY
2261210	10" X 1/2" CLEAR	25 LBS
22612101	10" X 1/2" TAN	25 LBS

STAPLERS AND STAPLES

STAPLING PLIER (LISTED WITH STAPLES USED)

Heavy Duty plier. Uses 1/4", 3/8", and 1/2" staples of thick .050" wire.



ITEM NO.	DESCRIPTION	SIZE/LEG LENGTH	QUANTITY
225311	RAPID 31 POINT STAPLING PLIER SWORD POINT		
2253820	694-9 STAPLES	3/8	5000 PER BOX, 20 BOXES PER CASE
22569412	694-12	1/2	5000 PER BOX

STAPLERS AND STAPLES CONTINUED

**PNEUMATIC AND MANUAL 3/4" STAPLERS
(LISTED WITH STAPLES USED)**

JK561/18 PNEUMATIC 3/4" STAPLER

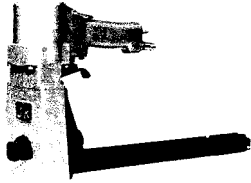

The 561/18P is an air powered version of the 561/18. Weight: 5.5 lbs.

JK561/18 3/4" MANUAL STAPLER

The 561/18 uses 3/4" leg staples for double wall corrugated top closing. Weight: 3 lbs.

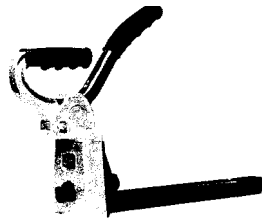

**PNEUMATIC AND MANUAL 5/8" STAPLERS
(LISTED WITH STAPLES USED)**

**561/15 JK HAND (MANUAL)
CARTON STAPLER**



The 561/15 uses the most common 1-1/4 x 5/8 staples. Loads 150 staples. Used for single wall corrugated top closing.

B561 JK PNEUMATIC CARTON BOTTOM STAPLER

The B561 machine can use 5/8, 3/4, and 7/8" leg staples to close single, double, and triple wall corrugated board. It is air powered. Loads 300 staples. Weight 105 lbs. Throat depth: 15-3/4". Post height: 45".



JK 561/15 PNEUMATIC 5/8" STAPLER

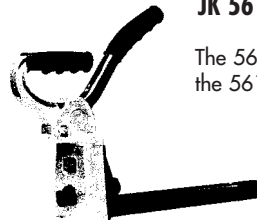

The 561/15P is an air powered version of the 561/15.

ITEM NO.	DESCRIPTION	SIZE/ LEG LENGTH	QUANTITY
225561181	JK561/18 PNEUMATIC 3/4" STAPLER		
225561182	JK561/18 3/4" MANUAL STAPLER		
22534	C34 STAPLES	1-1/4 X 3/4	20,000 PER CASE
2255611811	561/18 STAPLES	3/4	25,000 PER CASE

**B561 POST FOOT OPERATED
MANUAL STAPLER**

This B561 is the manual version of the B561 Pneumatic listed above.

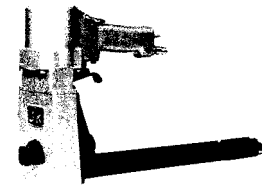

ITEM NO.	DESCRIPTION	SIZE/ LEG LENGTH	QUANTITY
2255612	561/15 JK HAND (MANUAL) CARTON STAPLER		
2255613	B561 JK PNEUMATIC CARTON BOTTOM STAPLER		
225561151	JK 561/15 PNEUMATIC 5/8" STAPLER		
2255611	B561 POST FOOT OPERATED MANUAL STAPLER		
225581	C58 STAPLES	1-1/4 X 5/8	20,000 PER CASE
22556115	561/15 GALVANIZED STAPLES	1-1/4 X 5/8	25,000 PER CASE
225561152	561/15 COPPER STAPLES	1-1/4 X 5/8	25,000 PER CASE



STAPLERS AND STAPLES CONTINUED

**HAND CARTON STAPLER
(LISTED WITH STAPLES USED)**

The D16-2 is a rugged top closer designed to use all 5 Bostitch stick-type carton staples in 5/8, 3/4, and 7/8" leg lengths. Suitable for single and double wall top closing. Weight: 7 lbs.



SW7437 BOSTITCH CARTON STRIP STAPLES

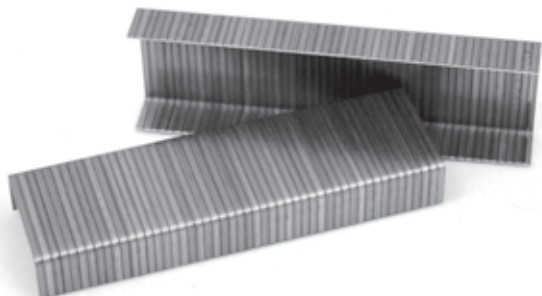

ITEM NO.	DESCRIPTION	SIZE/ LEG LENGTH	QUANTITY
2250162	D16-2 BOSTITCH HAND CARTON STAPLER		
22574374	SW7437 BOSTITCH CARTON STRIP STAPLES	5/8	24,000 PER CASE
2259040	9040 STAPLE	5/8	20,000 PER CASE
22590401	9040 STAPLE	3/4	20,000 PER CASE

**HOG RING PLIER STAPLER
(LISTED WITH STAPLES USED)**

The P7 Hog Ring plier is used for closing bags, attaching fabric to dowels and cables, and other unusual applications. The staple is 1 1/16" wide at the opening and closes down to 3/16" diameter after clinching. Steel rings are sharp or blunt.

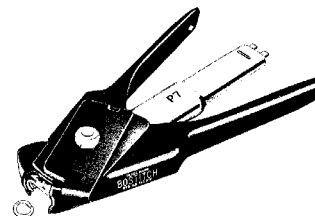

ITEM NO.	DESCRIPTION	SIZE/ LEG LENGTH	QUANTITY
225007	BOSTITCH P7 HOG RING PLIER STAPLER		
2256162	RING616G50 SHARP HOG RING STAPLE	1 1/16" OPEN / 3/16" CLINCHED	2500 PER BOX, 10 BOXES PER CASE

**AIR PLIER STAPLER
(LISTED WITH STAPLES USED)**

The P50 is a versatile tool for fastening corrugated containers, container inserts, telescoping boxes, end caps, and tray corners.



ITEM NO.	DESCRIPTION	SIZE/ LEG LENGTH	QUANTITY
2250050	P50 BOSTITCH AIR PLIER STAPLER		
225103020	SB103020 BOSTITCH STAPLE	1/2	2200 PER BOX, 20 BOXES PER CASE
2251030201	SB103020 BOSTITCH STAPLE	5/8	2500 PER BOX, 20 BOXES PER CASE

SHIPPING SUPPLIES

STAPLERS AND STAPLES CONTINUED

**HIGH SPEED HEAVY DUTY ELECTRIC STAPLER
(LISTED WITH STAPLES USED)**

RAPID 105 HIGH SPEED HEAVY DUTY ELECTRIC STAPLER

The 105 is capable of continuous use in header card and other production applications. It has an automatic trip to adjust staple from 1/4" to 3-1/2" from the edge. Two can be linked with a cable and dual base for simultaneous operation. A foot pedal trigger is an optional accessory.

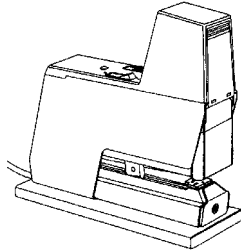

RAPID 106 ELECTRIC STAPLER

The 106 is designed for booklet binding operations. The slanted table can be righted for flat stapling like the 105.

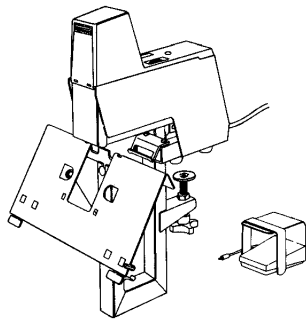

210/6 STAPLES

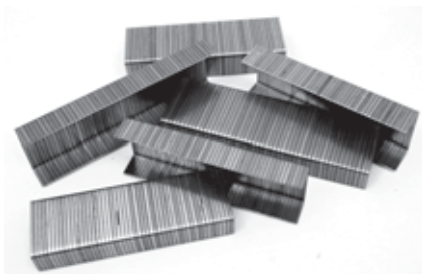

ITEM NO.	DESCRIPTION	SIZE/ LEG LENGTH	QUANTITY
225105	RAPID 105 HIGH SPEED HEAVY DUTY ELECTRIC STAPLER		
225106	RAPID 106 ELECTRIC STAPLER		
225210	210/6 STAPLES	1/4	5000 PER BOX, 20 BOXES PER CASE

**HAMMER STAPLER
(LISTED WITH STAPLES USED)**

Light wrist action drives staples and swings like a hammer. Uses small 3/8" crown staples with 1/4" or 5/16" legs.

ITEM NO.	DESCRIPTION	SIZE/ LEG LENGTH	QUANTITY
225191	RAPID 19 HAMMER STAPLER		
22519141	RAPID HAMMER 19 STAPLES	1/4	5000 PER BOX, 50 BOXES PER CASE

**TACKER STAPLER
(LISTED WITH STAPLES USED)**

The 23 Tacker uses 1/4" and 3/8" leg staples.



ITEM NO.	DESCRIPTION	SIZE/ LEG LENGTH	QUANTITY
22523	RAPID 23 TACKER STAPLER		
225231	RAPID 23 TACKER STAPLES	5/16	5000 PER BOX, 50 BOXES PER CASE

The 33 Tacker has an adjustable pressure design and uses 1/4, 3/8, 1/2, and 9/16" staples.



ITEM NO.	DESCRIPTION	SIZE/ LEG LENGTH	QUANTITY
22533	RAPID 33 TACKER STAPLER		
225331	RAPID 33 TACKER STAPLES	5/16	5000 PER BOX, 60 BOXES PER CASE
2253311	RAPID 33 TACKER STAPLES	5/16	5000 PER BOX, 60 BOXES PER CASE

SHIPPING SUPPLIES

STAPLERS AND STAPLES CONTINUED

**COIL FED TOP STAPLER / CLOSER
(LISTED WITH STAPLES USED)**

The D60ADC is a coil fed top closer that dispenses 1000 staples before reloading. It uses 1/2, 5/8, and 3/4" length leg staples. Weight: 5.5 lbs (7.5 lbs with a new roll loaded).



ITEM NO.	DESCRIPTION	SIZE/ LEG LENGTH	QUANTITY
225060	BOSTITCH D60ADC COIL FED TOP STAPLER 1M/COIL		
7027437	BOSTITCH LC SWC 7437 COIL STAPLES	5/8	1000 PER COIL, 24 COILS PER CASE

**HEAVY DUTY STAPLER
(LISTED WITH STAPLES USED)**

ITEM NO.	DESCRIPTION	SIZE/ LEG LENGTH	QUANTITY
2252	RAPID 2 HEAVY DUTY STAPLER		
225210	210/6 STAPLES	1/4	5000 PER BOX, 100 BOXES PER CASE

**HAND PLIER FOR VERY LIGHT
GAUGE WIRE STAPLES
(LISTED WITH STAPLES USED)**

The 02245 Plier has many uses in manufacturing and packaging. It uses .021" gauge wire that is suitable for tagging and easy removal. It is very comfortable for continuous use.

ITEM NO.	DESCRIPTION	SIZE/ LEG LENGTH	QUANTITY
7038	BOSTITCH 02245 (B-8P) PLIER STAPLER		
2252115	BOSTITCH STCRP2115 STAPLE	1/4	5000 PER BOX, 20 BOXES PER CASE

**HAND PLIER FOR LIGHT GAUGE WIRE STAPLES
(LISTED WITH STAPLES USED)**

The P6C-6 Plier has many uses in manufacturing and packaging. It uses narrow gauge .026" gauge wire for piercing.

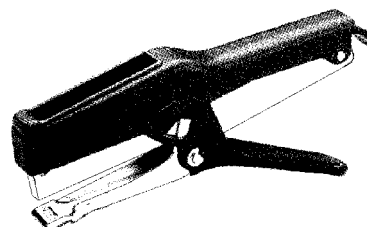

ITEM NO.	DESCRIPTION	SIZE/ LEG LENGTH	QUANTITY
2250606	P6C-6 BOSTITCH HAND PLIER FOR .026 LIGHT GAUGE WIRE STAPLES		
22502619	STCR-2619 .026 LIGHT GAUGE WIRE	1/4	5000 PER BOX, 40 BOXES PER CASE
225002619	STCR-2619 .026 LIGHT GAUGE WIRE	3/8	5000 PER BOX, 40 BOXES PER CASE

**HAND PLIER FOR WIRE STAPLES
(LISTED WITH STAPLES USED)**

BOSTITCH H30-8 STAPLER HAMMER TACKER FOR .050 GAUGE WIRE STAPLES (1/4 AND 3/8)

The H30-8 is commercial grade. Lightweight hammer that applies both 1/4" and 3/8" staples of .050" gauge. Lightweight wrist action drives staples and swings like a hammer. Great for repetitive tacking jobs where speed is important.



BOSTITCH P6C-8 PLIER STAPLER FOR .050 GAUGE WIRE STAPLES (1/4 AND 3/8)

The P6C-8 Plier has many uses in manufacturing and packaging. It uses .050" gauge wire for strong hold of corrugated board and jiffy mailing bag material. Staples come in 1/4" and 3/8" lengths. It is very comfortable for continuous use.

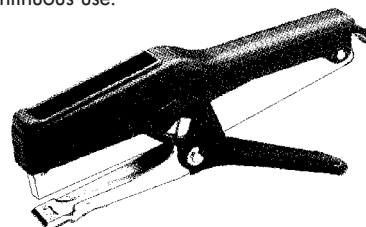

SHIPPING SUPPLIES

STAPLERS AND STAPLES CONTINUED

BOSTITCH PC4000 TACKER FOR .050 GAUGE WIRE STAPLES (1/4, 3/8 AND 1/2)

The PC400 Tacker uses heavy duty wire staples in 1/4, 3/8, and 1/2" leg lengths.



ITEM NO.	DESCRIPTION	SIZE/ LEG LENGTH	QUANTITY
225308	BOSTITCH H30-8 STAPLER HAMMER TACKER FOR .050 GAUGE WIRE STAPLES (1/4 AND 3/8)		
2250608	BOSTITCH P6C-8 PLIER STAPLER FOR .050 GAUGE WIRE STAPLES (1/4 AND 3/8)		
2254000	BOSTITCH PC4000 TACKER FOR .050 GAUGE WIRE STAPLES (1/4, 3/8 AND 1/2)		
2255019	STCR5019 STAPLES	1/4	6000 PER BOX, 20 BOXES PER CASE
22550192	STCR5019 STAPLES	3/8	5000 PER BOX, 10 BOXES PER CASE
22550194	STCR5019 STAPLES	9/16	4000 PER BOX, 10 BOXES PER CASE
22050195	STCR5019 STAPLES	1/2	4000 PER BOX, 10 BOXES PER CASE

STAPLE REMOVER

Pressure sensitive backing attaches to almost anything – paper, wood, plastic, metal. Outside dimensions listed. For the inside dimensions, deduct 1/2".



ITEM NO.	DESCRIPTION
225271	G-27W CARTON STAPLE REMOVER

OTHER STAPLES

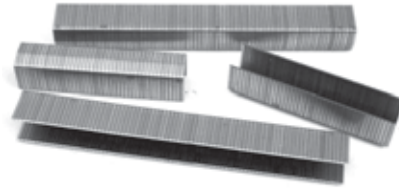

ITEM NO.	DESCRIPTION	SIZE/ LEG LENGTH	QUANTITY
22558	A58 STAPLES	1-3/8 X 5/8	20,000 PER CASE
225342	A34 STAPLES	1-3/8 X 3/4	20,000 PER CASE
2251581	AL RRI-58 STAPLES	5/8	1000 PER ROLL, 20 ROLLS PER CASE
225034	RRI-34 STAPLES	1-1/4 X 3/4	1000 PER ROLL, 20 ROLLS PER CASE
22555621	W5562 STAPLES	1 X 3/4	10,000 PER CASE
2253109	310/9 STAPLES	3/8"	5000 PER BOX, 20 BOXES PER CASE

EDGE PROTECTION

**VBOARD
(Also known as Angle Board)**

Edge protectors prevent damage to corners and edges of packaged and palletized items. A variety of sizes shapes and thicknesses are available. Custom printing for labeling, warning or branding is also available. If you do not see what you need listed here, please contact your Acorn Paper Products representative for assistance.

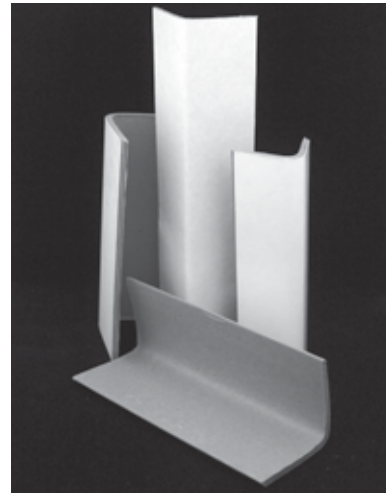

ITEM NO.	SIZE (W X L)	CALIPER	PIECES PER PALLET	FEET PER PALLET
235020236120	2" X 2" X 36"	0.12	2808	8424
235020236160	2" X 2" X 36"	0.16	2106	6318
235020272160	2" X 2" X 72"	0.16	2106	12,636
235020236225	2" X 2" X 36"	0.225	1560	4680
2350202362251	2 1/2" X 2 1/2" X 36"	0.225	1320	3960
235020242225	2 1/2" X 2 1/2" X 42"	0.225	1320	4620
2350202482251	2 1/2" X 2 1/2" X 48"	0.225	1320	5280

EDGE PROTECTION CONTINUED

ITW

Acorn Paper Products is proud to offer the following ITW products for package handling and protection needs along with the entire ITW product line. Please contact your Acorn Paper Products representative for more information or a custom printing quote.

Angleboard®

Angleboard® paper edge protection helps repel and absorb corner impacts and prevents strapping from damaging load corners. Angleboard provides greater load unitization, stacking strength and material savings when combined with strapping or stretch film. Most Angleboard is fully wrapped with an outer layer of paper, providing a cleaner, crisper appearance, extra strength and added protection. The smooth edges also prevent paper cuts.

- 100% paper
- Crisp, clean appearance
- Smooth edges
- 2-color printing available
- Recycled and recyclable

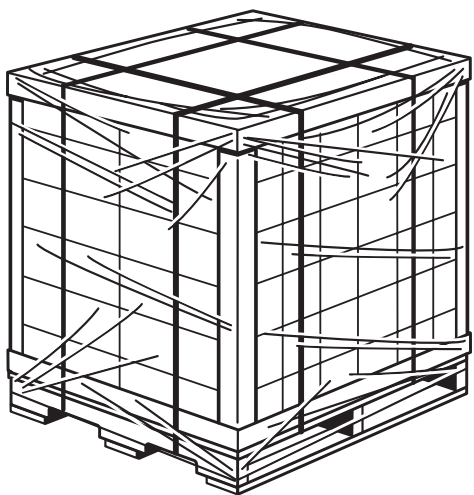

Cornerboard®

Manufactured from recycled paper and plastic, Cornerboard® provides exceptional strength and rigidity for the most demanding applications. This patented corner protection product enables palletized loads to be strapped with greater tension, ensuring maximum load security during transit. Cornerboard also accepts nails, staples and screws.

- Coextruded paper and plastic
- Water resistant
- Exceptional strength
- 2-color printing available
- Recycled and recyclable



I.D. / O.D. Protectors

This economical line of products provides protection inside and out on round items.

- Great for protecting coil and roll edges
- Uniquely design for inside and outside diameters
- Available in standard and custom-made thicknesses and sizes

