

STEEL STRAPPING

Acorn Paper Products carries an extensive line of strapping, banding and tying supplies and accessories. If you do not see what you need listed here, please contact your Acorn Paper Products representative for assistance.



REGULAR DUTY, 95-100 LBS. APPROX. WT. PER COIL

A low carbon form of steel strapping made for low to medium usage. Use for package reinforcement, unitizing, palletizing, box closures and bundling. Contact your Acorn Paper Products representative for more information on all strapping products including medium and heavy duty steel strapping.

ITEM NO.	WIDTH	THICKNESS	TENSILE STRENGTH (APPROX.) LB.	FEET PER LB. (APPROX.)
24238209	3/8"	.020"	880	39.2
24250209	1/2"	.020"	1175	29.4
24215020	1/2" ZINC COAT	.020"	1175	29.4
24250239	1/2"	.023"	1350	25.6
24258209	5/8"	.020"	1470	23.5
24258209	5/8" ZINC COAT	.020"	1470	23.5
24258231	5/8"	.023"	1685	20.5
24275159	3/4"	.015"	1335	26.2
24275209	3/4"	.020"	1765	19.6
2425239	3/4"	.023"	2025	17.1

SEALS

OPEN, SNAP-ON, REGULAR DUTY

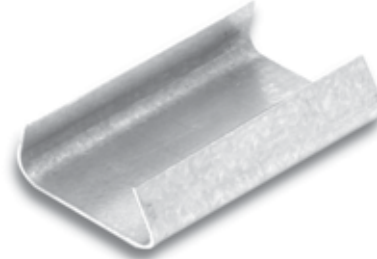

Acorn Paper Company carries a variety of seals for all your strap sealing needs. Open seals snap onto overlapping strap prior to tensioning.

ITEM NO.	WIDTH	LENGTH	CASE
2361502	1/2"	1"	2500
2361503	5/8"	1"	2500
2361504	3/4"	1 3/32"	2500

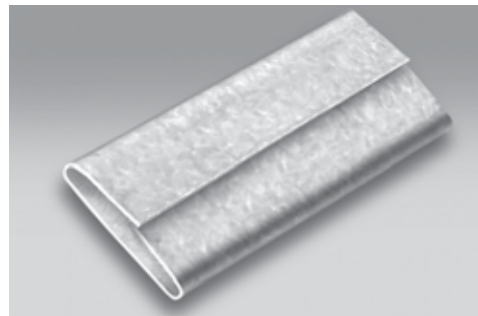

CLOSED/PUSH-TYPE, OVERLAP, REGULAR DUTY

Closed seals are used for push type tensioners.

ITEM NO.	WIDTH	LENGTH	CASE
24213834	3/8"	3/4"	1000
2421511	1/2"	1"	1000
2421533589	5/8"	1"	1000
2421534	3/4"	1"	2500

CLOSED/PUSH-TYPE, OVERLAP, HEAVY DUTY

ITEM NO.	WIDTH	LENGTH	CASE
236175000	3/4"	1 25/32"	2000
236125225	1 1/4"	2 1/4"	1000

STEEL STRAPPING CONTINUED

MANUAL STEEL STRAPPING TENSIONERS

Acorn Paper Company carries a variety of tensioning tools for all your strapping needs. Tools are available to fit a full range of strapping widths and thicknesses. Contact your Acorn Paper Products representative for more information.



ITEM NO.	STRAP SIZE	TYPE
2362901	3/8" TO 3/4"	STEEL STRAP TENSIONER
2361916	3/8" TO 3/4"	MEDIUM STEEL
236176010	3/4" TO 1 1/4"	HEAVY DUTY STEEL

MANUAL STEEL STRAPPING SEALERS

Acorn Paper Company carries a variety of sealing tools including notch sealers and crimpers.

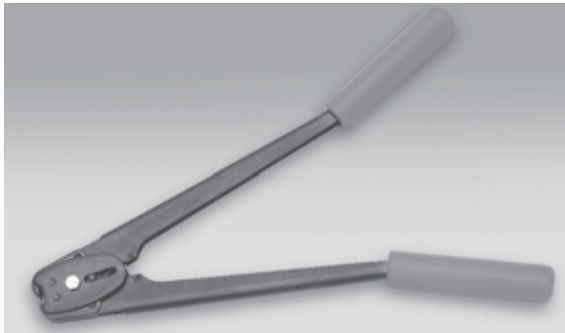

ITEM NO.	STRAP SIZE	TYPE
2421015	.015" TO .023"	HEAVY DUTY DOUBLE NOTCH
2421952123	1/2"	SEALER / CRIMPER
80158	5/8"	SEALER / CRIMPER
24219541	3/4"	SEALER / CRIMPER

OTHER STEEL STRAPPING TOOLS

SEALLESS COMBINATION TOOLS

Acorn Paper Company carries a variety of strapping tools in manual and automatic varieties. Our power tools vary from light duty through high capacity and fully-automated. Tools are available to fit a full range of strapping widths and thicknesses. Sealless Pneumatic Combination Tools For High Tensile Strapping is also available. Contact your Acorn Paper Products representative for more information.

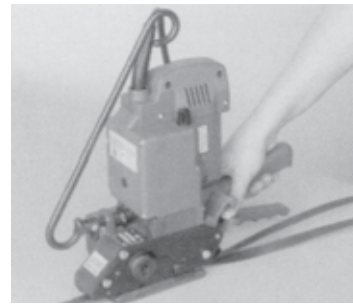

ITEM NO.	STRAP SIZE	TYPE
23610515	1/2" X .015 TO .023	REGULAR DUTY
235162515	5/8" X .015 TO .023	REGULAR DUTY
23617515	3/4" X .015 TO .023	REGULAR DUTY

STEEL STRAPPING DISPENSERS

Standard

Our regular duty steel strapping dispenser accepts 3", 6" and 8" face coils as well as 8" and 16" cores. It includes sturdy wheels and a tool tray.

Heavy Duty

This heavy duty steel strapping dispenser accepts up to 2" wide face coils and 16" inner core strap. It also includes a strap troller, tool tray and sturdy wheels.



ITEM NO.	TYPE
2361	STANDARD DUTY WITH TOOL TRAY
23611	HEAVY DUTY WITH TOOL TRAY

STEEL STRAPPING CONTINUED

STEEL STRAPPING SHEARS

These heavy duty shears will cut steel strap in widths from 3/8" up to 1 1/4".

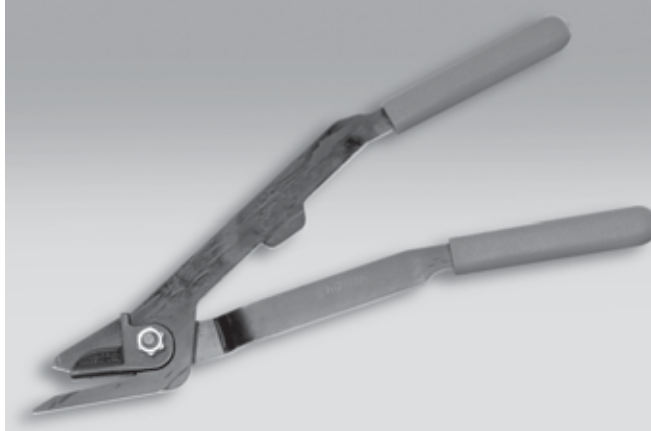

ITEM NO.	STRAP SIZE
2360152	3/8" - 1 1/4"

Determining The Core Size for Steel or Poly Strapping.

First, measure the inside diameter of the coil (1).
Second, measure the width of the coil (2).
Easy way to remember: Always measure inside-out.

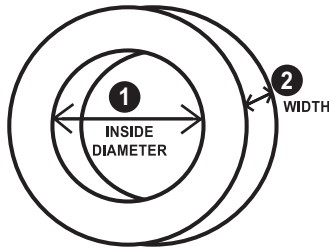

TYPICAL CORE SIZES:

- 16" x 6"
- 16" x 3"
- 8" x 8"
- 9" x 8"
- 11" x 8"
- 4" x 6"
- 8" x 6"

POLYPROPYLENE STRAPPING

Polypropylene strapping is a cost effective material that can also save labor costs. Because it stretches slightly when tensioning and then reduces, it will firmly hold contents. Naturally rust and chemical resistant, it is also lighter in weight and more flexible than steel strapping products. Contact your Acorn Paper Products representative for more information on plastic strapping.

HAND GRADE POLYPROPYLENE

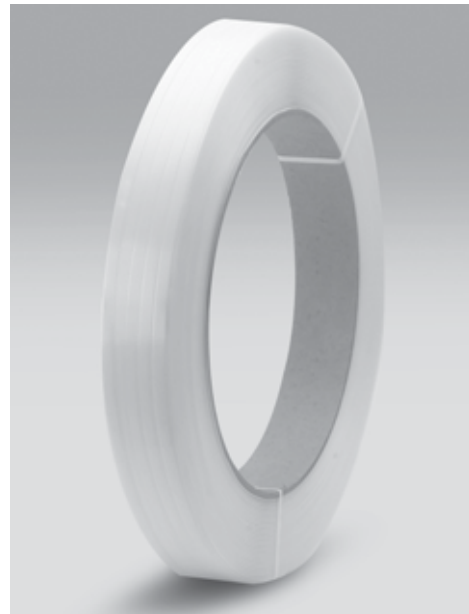

ITEM NO.	WIDTH /THICK.	LENGTH (FT.)	TENSILE STRENGTH (APPROX.) LB.	CORE SIZE	COLOR
9419200	3/8" X .020	12,900	250	9" X 8"	BLACK
2413004	1/2" X .017"	9000	350	8" X 8"	BLACK
24130041	1/2" X .017"	9000	350	8" X 8"	YELLOW
241603	1/2" X .031"	3600	600	16" X 3"	BLACK
2413008	1/2" X .017"	9000	350	16" X 6"	BLACK
2416004	1/2" X .031"	7200	600	8" X 8"	YELLOW
24160041	1/2" X .031"	7200	600	8" X 8"	BLACK
2416008	1/2" X .031"	7200	600	16" X 6"	YELLOW
2416009	1/2" X .031"	7200	600	16" X 6"	BLACK
2417003	5/8" X .025	2600	700	16" X 3"	BLACK
2419003	5/8" X .031"	2200	900	16" X 3"	BLACK
24110504	5/8" X .033	4500	1050	8" X 8"	BLACK

Other Sizes, Strengths and Colors are available

PLASTIC STRAPPING

POLYPROPYLENE STRAPPING

MACHINE GRADE POLYPROPYLENE

ITEM NO.	WIDTH /THICK.	LENGTH (FT.)	TENSILE STRENGTH (APPROX.) LB.	CORE SIZE	COLOR
241926500	3/8" X .022"	12,900	300	9" X 8"	WHITE
2418300	1/2" X .022"	9900	350	8" X 8"	WHITE
24183001	1/2" X .022"	9900	350	8" X 8"	BLACK
2419300	1/2" X .022"	9900	300	9" X 8"	WHITE
24175005	1/2" X .025"	7500	350	11" X 8"	WHITE
24160005	1/2" X .031"	6000	600	16" X 6"	BLACK

Other Sizes, Strengths and Colors are available

STRAPPING KIT

Dispenser packs provide packaging systems for the manual strapper that are convenient, economical and easy to use. Each kit is a total, self-contained unit that includes one coil of strapping, metal wire buckles and a T-bar tensioner. Tough polypropylene strapping has memory for shock absorption and load stress handling and shipping.



ITEM NO.	WIDTH	LENGTH (FT.)	TENSILE STRENGTH (APPROX.) LB.	COLOR
3413000	1/2"	3000'	300	BLACK
23630001	1/2"	6000'	300	BLACK

POLYESTER STRAPPING

Use with hand tools or machine. Polyester strapping provides excellent impact resistance, low elongation and more break strength around corners and edges than steel. It is not affected by temperature and moisture. A replacement for steel in some applications and is safer than steel. Contact your Acorn Paper Products representative for an evaluation of all your strapping needs.

HAND OR MACHINE GRADE POLYESTER

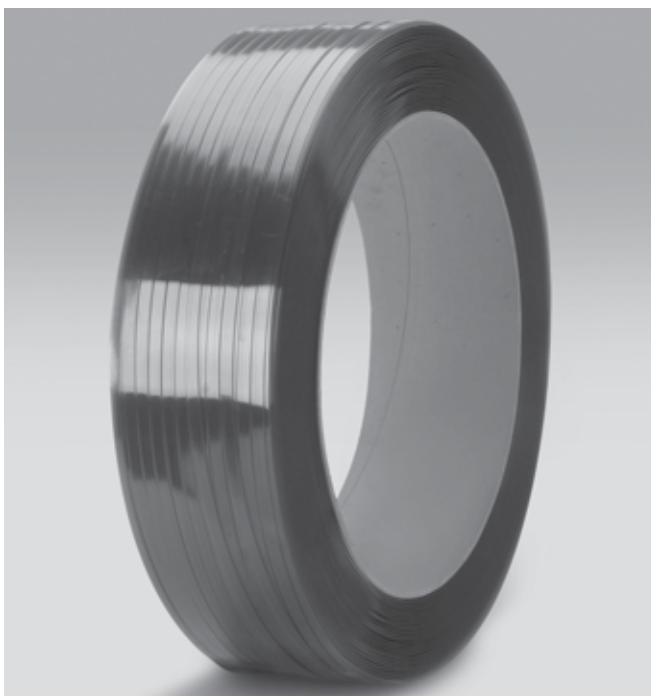

ITEM NO.	WIDTH /THICK.	LENGTH (FT.)	TENSILE STRENGTH (APPROX.) LB.	CORE SIZE	COLOR
2412600	.41" X .021"	10500	500	16" X 6"	GREEN
24126006	.41" X .024"	9000	600	16" X 6"	GREEN
2411600	.47" X .021"	9000	600	16" X 6"	GREEN
2411800	.47" X .024"	6500	800	16" X 6"	GREEN
24116005	1/2" X .020"	3600	600	16" X 3"	BLACK
2411775	1/2" X .025"	5800	775	16" X 6"	BLACK
241173065	5/8" X .020"	3850	750	16" X 3"	BLACK
2411775625	5/8" X .025"	5800	775	16" X 6"	GREEN
2411950	5/8" X .025"	2200	950	16" X 3"	BLACK
2411050	5/8" X .030	1800	1050	16" X 3"	BLACK

PLASTIC STRAPPING CONTINUED

BUCKLES AND SEALS

SEALS

Open Seals: Used for light, medium and heavy duty tensioning of all sizes of strapping. Open seals may be applied at any time before tension is released.

Closed Seals: Used for light and medium tensioning requirements and are available for all sizes of strapping. The seal must be threaded through the strap before the tensioning tool is used.

Serrated Strapping Seals: Used with polyester strap. These seals are made from prime quality galvanized steel.

Please contact your Acorn Paper Products representative for more sizes and information.

OPEN SEALS



CLOSED SEALS

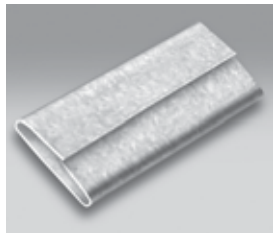

SERRATED SEALS

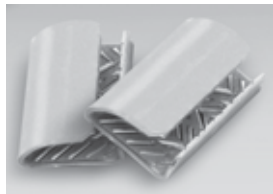

ITEM NO.	SIZE	TYPE	CASE
2362005	1/2"	OPEN	1000
2362625	5/8"	OPEN	1000
23620052	1/2"	CLOSED	1000
23626252	5/8"	CLOSED	1000
241341	3/4"	CLOSED	1000
241175112	1/2"	SERRATED	1000
23626253	5/8"	SERRATED	1000

TOOLS

CUTTER FOR PLASTIC STRAPPING

Acorn Paper Products carries an extensive line of tools for plastic strapping. If you do not see what you need listed here, please contact your Acorn Paper Products representative for assistance.



ITEM NO.	TYPE
23602	PLASTIC AND STEEL CUTTER

SEALERS / CRIMPERS FOR PLASTIC STRAPPING

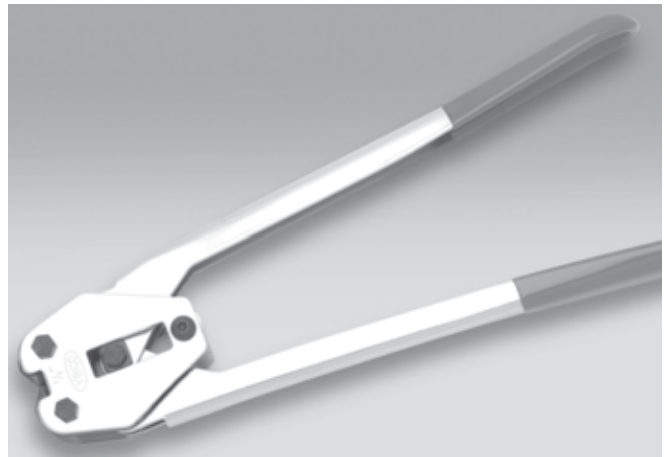

ITEM NO.	TYPE	STRAP SIZE
2360123	ECONOMY	1/2"
242058	ECONOMY	5/8"
242212	HEAVY DUTY	1/2"
242258	HEAVY DUTY	5/8"

STRAPPING & TYING

PLASTIC STRAPPING CONTINUED

TOOLS

TENSIONER FOR PLASTIC STRAPPING

ITEM NO.	TYPE	STRAP SIZE
236458	T-BAR HAND	ALL
23601	ECONOMY	UP TO 5/8"
236380	HEAVY DUTY	UP TO 3/4"

ECONOMY TENSIONER



T BAR HAND TENSIONER



FOR USE WITH PLASTIC STRAPPING

DISPENSERS FOR PLASTIC STRAPPING

Our regular duty universal strap dispenser accepts 3", 6" and 8" face coils, as well as 8" and 16" cores. It includes sturdy wheels and a tool tray.



ITEM NO.	TYPE
236368	STRAPPING CART

CORNER PROTECTORS

PLASTIC CORNER PROTECTORS

Protects the edge of items that come in contact with the strap. Other corner protective items, such as v-board are available in other sections of this catalog. Please contact your Acorn Paper Products representative for assistance in evaluating your needs.

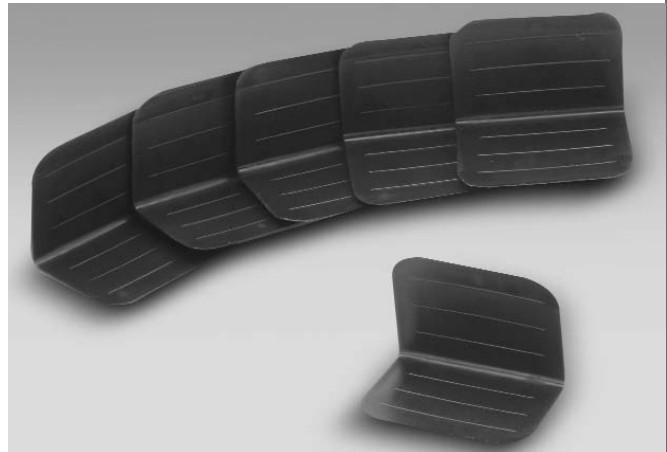

ITEM NO.	TYPE	CASE
236122	2 1/5" WIDTH X 1 3/4" LENGTH, BLACK	1000

AUTOMATED STRAPPING MACHINERY

SP4 SEMI AUTOMATIC STRAPPING MACHINE

The SP4 is a semi-automatic strapping machine that features an instant heat design, solid state electronics and HP drive motor. It has a patented electromagnetic tension detector with outside tension adjustment to 100 lbs.. It has an automatic strap feed length dispenser, adjustable table height and automatic motor shut off. It features a PC board control system with 60 second auto shut off and cool time adjustment. It can be used with strap widths of 3/8" to 5/8".



TP101 AUTOMATIC STRAPPING MACHINE

The TP101 is an automatic strapping machine that operates at up to 27 straps per minute and has an adjustable external tension control knob with adjustment up to 175 lbs. Its roller table makes it easy to use with heavy cartons. It can be used with strap widths of 3/8" to 1/2". Other features are adjustable strap cooling, automatic cycle switch, automatic motor shut off and self-lubricating components.



SAMUEL PACKAGING

P625 SEMI AUTOMATIC STRAPPING MACHINE

The P625 is a semi-automatic strapping machine that features a fast 5 second heater blade warm up time and uses a safe low voltage control. It also touts adjustable packaging guides and high speed transmission. It's heavy duty casters and 110 volt usage makes it very portable.



P230 AUTOMATIC STRAPPING MACHINE

The P230 is an automatic strapping machine that operates at up to 24 straps per minute and has an adjustable tension. It is an economical, low maintenance unit for moderate production requirements. It features heavy duty construction along with ease of portability and strap loading. Other conveniences include a cycle-ready indicator, pushbutton strap re-feed and table top ball switch.



AUTOMATED STRAPPING MACHINERY CONTINUED

SAMUEL PACKAGING

P710 AUTOMATIC STRAPPING MACHINE

The P710 is an automatic strapping machine that operates at up to 40 cycles per minute and has an adjustable tension range of 4.5 to 145 lbs. It features a loop injector and roller table top. Other conveniences include a large castors, auto re-feed, top load auto feed, foot and table top switches, emergency stop button and a removable control module.



Other packaging and strapping machines are available.

TYING

TWINE

COTTON WRAPPING TWINE

Cotton twin is available from 8 to 16 ply. It is available in 2-1/2 and 5 lb. cones. Acorn paper carries cotton twine for many uses including retail, general purpose and automatic tying machines. Please contact your Acorn Paper Products Sales representative for more information.



ITEM NO.	PLY		FEET PER LB.	TENSILE LBS.	PACK
5# Cones					
240008	8	8 YARNS/PLY	2400	23	12
2400910	10	8 YARNS/PLY	1950	28	12
2400912	12	8 YARNS/PLY	1600	34	12
2400916	16	8 YARNS/PLY	1200	45	12
2-1/2 # Cones					
2400908	8	8 YARNS/PLY	2400	23	20
240010	10	8 YARNS/PLY	1950	28	20
2400912	12	8 YARNS/PLY	1600	34	20
2400916	16	8 YARNS/PLY	1200	45	20



TYING

TWINE

POLYESTER WRAPPING TWINE

This pure white twin is often used as a low cost replacement for cotton twine. It is available in 2-1/2 and 5 lb. cones.



ITEM NO.	PLY	FEET PER LB.	TENSILE LBS.	PACK
2400906	6	3200	29	18 CONES X 5 LBS.
2400908	8	2400	49	18 CONES X 5 LBS.
2400916	16	1200	80	20 CONES X 2-1/2 #
2400920	20	1008	100	20 CONES X 2-1/2 #

SISAL TWINE

A fiber twine with a hard feel, it is one of the toughest twines made for heavy duty applications. It is free of oil and other residue.



ITEM NO.	PLY	FEET PER LB.	TENSILE LBS.	PACK
240101	1	360	200	6/10# TUBES
240102	2	176	360	6/10# TUBES
2404003	3	88	600	6/10# TUBES

POLY FILM TAPE

Use this as a replacement for cotton and polyester twines. This is a flat, film type, tape that can be used for binding tying, and grouping. Please contact your Acorn Paper Products Sales representative for more information on this item and its uses.

ITEM NO.	TYPE	SIZE	FEET PER TUBE	TENSILE LBS.	LBS. PER TUBE	COLOR
240281	FLAT	D-28	12000	40	10/ 4.4#	CLEAR
24017	FLAT	D-17	9900	25	20/ 2.2#	CLEAR

JUTE TWINE

This is a natural brown twine. Its softness makes it a perfect solution where human hands might be damaged by rougher twines.



ITEM NO.	PLY	FT/POUND	TYPE	TENSILE LBS.	LBS. PER TUBE
2400328	3	510'	28 LB.	85	6/10#
2400428	4	375'	28 LB.	115	6/10#
2400372	3	190'	72 LB.	250	6/10#
240472610	4	140'	72 LB.	328	6/10#
2400572	5	115'	72 LB.	340	6/10#
2400672	6	95'	72 LB.	350	6/10#

STRAPPING & TYING

TYING

TWINE

SPIRAL FILM SYNTHETIC WRAP TWINE

This synthetic, polypropylene twine, is not only rot and moisture resistant, but is one of the toughest twines available. Its bound multi-filament untwisted construction gives it its unparallel strength.

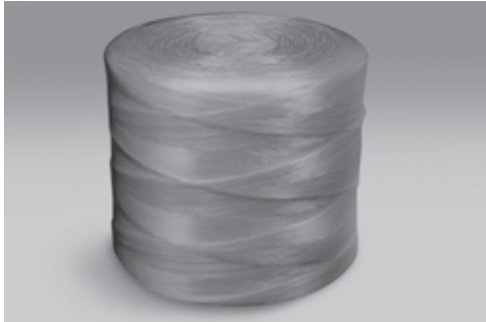

ITEM NO.	FEET PER LB.	TENSILE LBS.	PACK
230450	450	310	4/10#
230550	550	250	4/10#
2306501	650	200	4/10#
230850	850	160	4/10#
2301020	1050	135	4/10#
2301250	1250	110	4/10#

ROPE AND CORD

POLYPROPYLENE TRUCK ROPE BLACK & ORANGE

This is a multi-purpose rope that is used extensively in the trucking business and in warehouses for general tying. It is durable and flexible. Diameters of 3/8" to 1" add to its versatility.



ITEM NO.	DIAMETER	FEET PER ROLL	LBS. PER REEL
2410338	3/8"	600	17
24103716	7/16"	600	23
2410312	1/2"	600	29
2410358	5/8"	600	45
2410334	3/4"	600	65
2410311	1"	600	113

COTTON SASH BRAIDED CORD, 100 FT.

Natural cotton cord provides strength, flexibility and softness. Available in 100 foot "hanks", this is a good all-purpose cord.



ITEM NO.	SIZE NO.	DIAMETER	LENGTH	TENSILE LBS.	CASE COUNT
2410606	6	3/16"	100'	260	12 HANKS/CS
2410607	7	7/32"	100'	330	12 HANKS/CS
2410608	8	1/4"	100'	600	12 HANKS/CS
2410610	10	5/16"	100'	1000	12 HANKS/CS
2410612	12	3/8"	100'	1200	12 HANKS/CS



STRAPPING & TYING

TYING

ROPE AND CORD

NYLON SOLID BRAID CORD

This extremely strong, soft, light cord has excellent resistance to rot, abrasion, mildew, petroleum products and most chemicals. Has shock absorbing elasticity that allows it to withstand great strain. Solid braided construction stays round and works well in pulleys or around objects.



ITEM NO.	SIZE NO.	DIAMETER	LENGTH (FT.)	TENSILE LBS.	APPROX #/SPOOL
2400304	4	1/8"	600'	400	2
2400306	6	3/16"	800'	800	4
2400308	8	1/4"	200'	1250	3
2400310	10	5/16"	175'	1400	4
2400312	12	3/8"	125'	2500	4
2400316	16	1/2"	80'	4000	4

TIES

CABLE TIES

These nylon ties are designed for bundling, tying and fastening. They also provide an easy to use sealing method for closing bags. The high tensile strength of these ties makes them useful in critical application. They are easy to apply by hand with or with out tools.



ITEM NO.	LENGTH	DIAMETER	CASE
24000712	7 1/2"	1/16" - 1 3/4"	5000
2400011	11"	1/16" - 3"	5000
2400015	15"	1/16" - 4"	5000



STRAPPING & TYING